

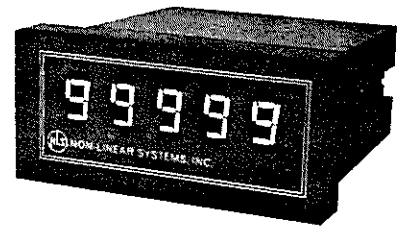

RC-5TB UNIVERSAL COUNTER

INSTRUCTIONS



INTRODUCTION.

The RC-5TB is a universal counter which may be programmed to perform any of the following functions: unit counting (totalizing), measurement of period, frequency, frequency ratio, and time interval. The counter employs large-scale integrated circuitry for reliability and ease of maintenance. Inputs to the counter can be electronic logic levels or contact-closures. Either single-pole double-throw or single-pole single-throw contact-closures can be accommodated.

The RC-5TB is designed to operate with a +5V ($\pm 5\%$) regulated power supply. See figure 1 for a typical +5V power supply circuit for operation from 115 VAC.

For unit count and frequency measurement, the input frequency range is 0 to 10 MHz. In frequency ratio measurement, the frequency signal (numerator) maximum is 10 MHz, but the reference frequency (denominator) maximum is 2.5 MHz; in period and time interval measurement, the input frequency maximum is 2.5 MHz. The display consists of five digits using red, light-emitting diodes. Character height is 0.5".

In frequency measurement, time bases of 0.01 second, 0.1 second, 1 second and 10 seconds are available. The selection is made with an internal jumper. In period, time interval and frequency ratio measurements, the number of cycles over which the measurement is averaged may be 1, 10, 100 or 1000. Selection is made with an internal jumper.

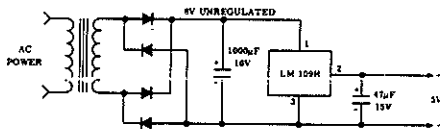

Figure 1. Typical Power Supply Schematic

SPECIFICATIONS.

Functions and Maximum Frequency Input:

- Unit Counter - 0 to 10 MHz
- Frequency - 0 to 10 MHz
- Time Interval - 0 to 2.5 MHz
- Period - 0 to 2.5 MHz
- Frequency Ratio - Signal, 0 to 10 MHz; Reference, 0 to 2.5 MHz

Power Supply: +5V $\pm 5\%$; 0.3 VA, nominal

Accuracy: Unit Counter & Frequency: ± 1 count. Frequency, Time Interval & Period: $\pm(1 \text{ count} + \text{time base accuracy})$.

Time Base

- Crystal Frequency: 10 MHz
- Time Bases: 0.01 Sec, 0.1 Sec, 1 Sec & 10 Sec

Crystal Stability

- Aging: < 10 ppm/yr
- Temperature: ± 10 ppm. 0°C to $+50^\circ\text{C}$

Operating Temperature: 0°C to $+50^\circ\text{C}$

Number of Digits: Five

Case: DIN/NEMA

Display: LED, 0.5" high

MOUNTING DATA.

A rectangular panel cutout is recommended for mounting the instrument. The recommended dimensions are:

92 millimeters ± 1 , -0 mm (3.622 inches ± 0.040 , -0 in.).

43 millimeters ± 1 , -0 mm (1.693 inches ± 0.040 , -0 in.).

The meters will also fit the DIN/NEMA standard cutout, 92 mm x 45 mm (3.622 in. x 1.772 in.) and the widely used 99.7 mm x 42.72 mm (3.925 in. x 1.682 in.) cutout.

Any panel thickness from 1.524 mm (0.060 in.) to 4.57 mm (0.18 in.) may be used.

To mount the meter, remove the retaining spring from its holes in the sides of the meter at the rear. Insert the meter from the front of the panel cutout. Replace the retaining spring and slide it behind the mounting panel to fasten the meter in place. It does not matter whether the retaining spring swings from above or below the meter.

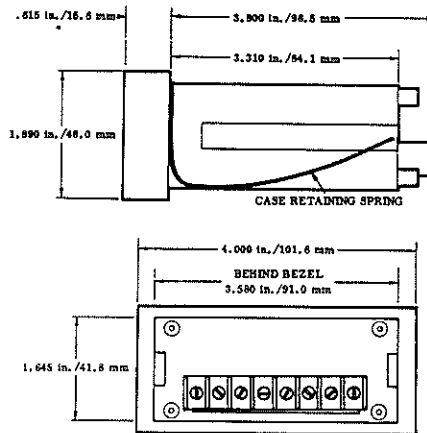

Figure 2. Outline Drawing

WIRING INFORMATION.

Connections to the RC-5TB are made externally via a terminal block. A 28-pin Program Header (X1 - see figure 3) is provided internally to jumper between various pairs of pins to select function, input method (contact-closure or electronic source), time base and the number of cycles over which certain measurements are averaged.

The instrument is normally shipped from the factory without any external connections or any jumpers connected to pins of the program header. Jumpers and a 0.5 μF capacitor are included with each instrument. The use of the capacitor is explained under Operation. When soldering jumpers or the capacitor into pins of the program header, care should be taken to avoid any solder spill-over from one pin to another

To gain access to the program header for the installation of jumpers and the capacitor, perform the following steps:

1. Remove any signal or power inputs to the terminal block.
2. Using a knife or a small screwdriver blade, carefully pry off front panel.
3. Remove the two screws and retaining brackets located to the right and left side of readout.
4. Slide meter out of case.

UNIT COUNT MEASUREMENT.

Maximum Count. 99999

Function Selection. Jumper between pins of program header as shown in figure 4"B".

Contact-Closure Input (Single-Pole Single-Throw).

1. Install capacitor and jumpers between pins of program header as shown in figure 5"A".
2. Reassemble instrument and connect inputs to terminal block as shown in figure 9"A".

Contact-Closure Input (Single-Pole Double-Throw).

1. Jumper between pins of program header as shown in figure 5"B".
2. Reassemble instrument and connect inputs to terminal block as shown in figure 9"B".

Electronic-Source Input (Rectangular Wave or Sine Wave above 10 kHz).

1. Jumper between pins of program header as shown in figure 5"C".
2. Reassemble instrument and connect inputs to terminal block as shown in figure 9"C".

Electronic-Source Input (Sine Wave below 10 kHz).

1. Jumper between pins of program header as shown in figure 5"D".
2. Reassemble instrument and connect inputs to terminal block as shown in figure 9"D".

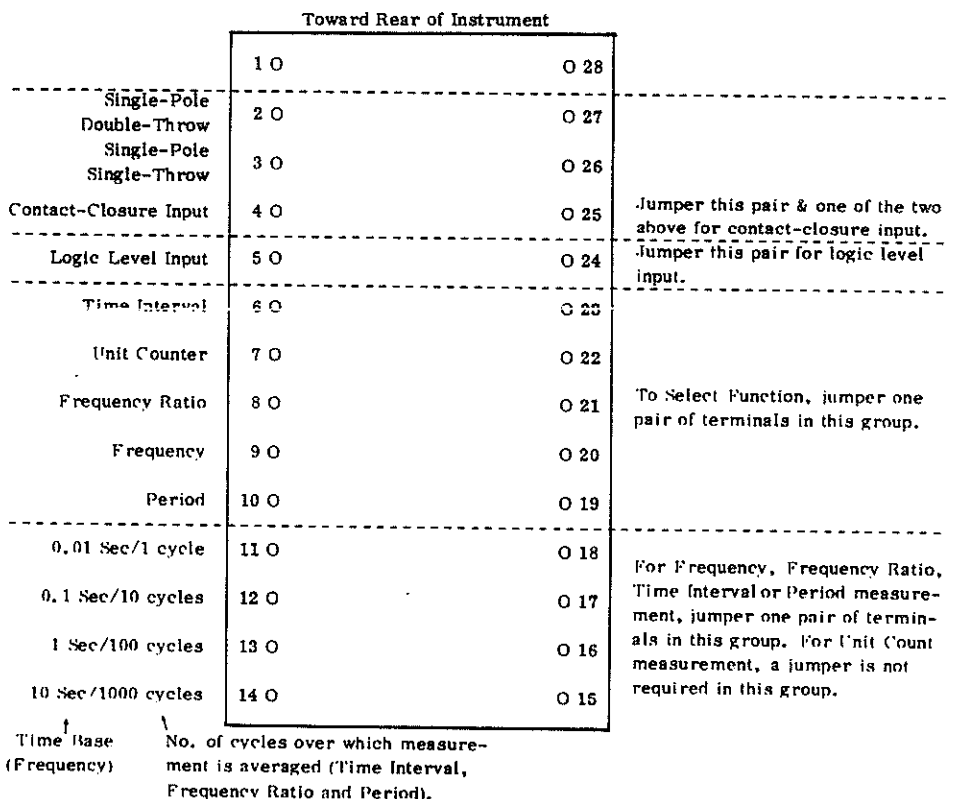

Figure 3. Program Header Pin Designations

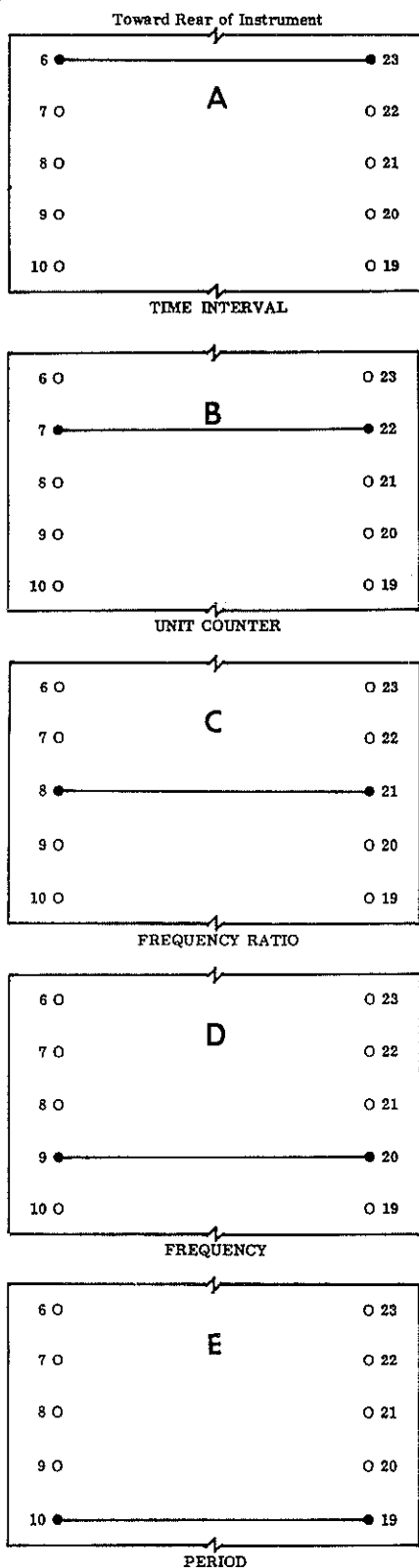

Figure 4. Function Selection

FREQUENCY MEASUREMENT.

Maximum Measurement Capability. Refer to table I.

Function Selection. Jumper between pins of program header as shown in figure 4"D".

Time Base Selection. Jumper between pins of program header as shown in figure 6"A" thru 6"D" to attain desired time base.

Input Circuit Selection. See applicable type of input circuit as described under Unit Count Measurement.

PERIOD MEASUREMENT.

Maximum Measurement Capability. Refer to table II.

Function Selection. Jumper between pins of program header as shown in figure 4"E".

Selection of Number of Cycles over which Measurement is Averaged. Jumper between pins of program header as shown in figure 6"A" thru 6"D" to attain desired number of cycles.

Input Circuit Selection. See applicable type of input circuit as described under Unit Count Measurement.

FREQUENCY RATIO MEASUREMENT.

Maximum Measurement Capability. Refer to table II.

Function Selection. Jumper between pins of program header as shown in figure 4"C".

Selection of Number of Cycles over which Measurement is Averaged. Jumper between pins of program header as shown in figure 6"A" thru 6"D" to attain desired number of cycles.

Input Circuit Selection.

NOTE

In frequency ratio measurement, the ratio is the signal applied to Input A (terminal 1 of the terminal block) or to terminals 5 and 7, or 5, 7 and 8 (contact-closures) divided by the reference signal applied to Input B (terminal 2 of the terminal block).

The reference frequency (Input B) must not exceed 2.5 MHz and must fall at a rate not less than 150 mV per μ Sec when crossing the +2V level. These conditions can be met with rectangular waves, or sine waves of any frequency between 10 kHz and 2.5 MHz and an amplitude of +5V peak-to-peak, going between 0V and +5V.

The following four types of input sources apply only to the frequency signal; the frequency reference is defined above and is always connected to terminal 2 of the terminal block.

Contact-Closure Input (Single-Pole Single-Throw).

1. Install capacitor and jumpers between pins of program header as shown in figure 5"A".
2. Reassemble instrument and connect inputs to terminal block as shown in figure 10"A".

Contact-Closure Input (Single-Pole Double-Throw).

1. Jumper between pins of program header as shown in figure 5"B".
2. Reassemble instrument and connect inputs to terminal block as shown in figure 10"B".

Electronic-Source Input (Rectangular Wave or Sine Wave above 10 kHz).

1. Jumper between pins of program header as shown in figure 5"C".
2. Reassemble instrument and connect inputs to terminal block as shown in figure 10"C".

Electronic-Source Input (Sine Wave below 10 kHz).

1. Jumper between pins of program header as shown in figure 5"D".
2. Reassemble instrument and connect inputs to terminal block as shown in figure 10"D".

Table I. Maximum Frequency Measurement

TIME BASE IN SECONDS	MAXIMUM FREQUENCY IN KILOHERTZ
0.01	9999.9
0.1	999.99
1.0	99.999
10.0	9.9999

Table II. Maximum Period, Time Interval and Frequency Ratio Measurement

NUMBER OF CYCLES USED IN AVERAGING	MAXIMUM PERIOD OR TIME INTERVAL IN MICROSECONDS	MAXIMUM FREQUENCY RATIO
1	9999.9	99999.
10	999.99	9999.9
100	99.999	999.99
1000	9.9999	99.999

TIME INTERVAL MEASUREMENT.

Maximum Measurement Capability. Refer to table II.

Function Selection. Jumper between pins of program header as shown in figure 4"A".

Selection of Number of Cycles over which Measurement is Averaged. Jumper between pins of program header as shown in figure 6"A" thru 6"D" to attain desired number of cycles.

Input Circuit Selection.

NOTE

The input of the start signal may be any one of the four previously described and as set forth below; the input of the stop signal must be a rectangular wave, or a sign wave above 10 kHz. Each signal must be a repetitive waveform.

Contact-Closure Input (Single-Pole Single-Throw).

1. Install capacitor and jumpers between pins of program header as shown in figure 5"A".
2. Reassemble instrument and connect inputs to terminal block as shown in figure 11"A".

Contact-Closure Input (Single-Pole Double-Throw).

1. Jumper between pins of program header as shown in figure 5"B".
2. Reassemble instrument and connect inputs to terminal block as shown in figure 11"B".

Electronic-Source Input (Rectangular Wave or Sine Wave above 10 kHz).

1. Jumper between pins of program header as shown in figure 5"C".
2. Reassemble instrument and connect inputs to terminal block as shown in figure 11"C".

Electronic-Source Input (Sine Wave below 10 kHz).

1. Jumper between pins of program header as shown in figure 5"D".
2. Reassemble instrument and connect inputs to terminal block as shown in figure 11"D".

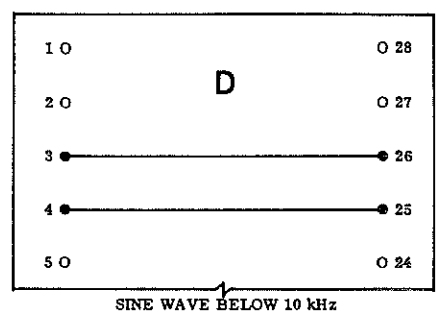
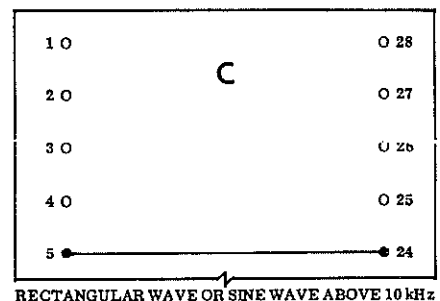
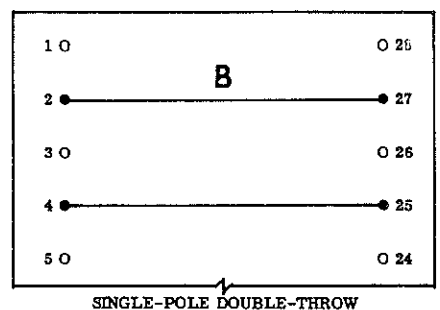
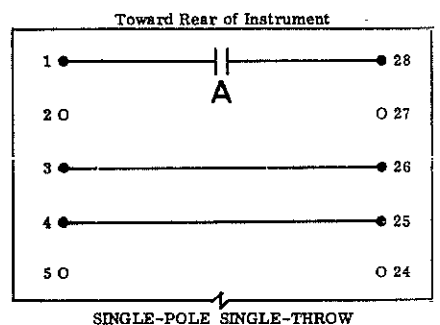

Figure 5. Input Circuit Selection

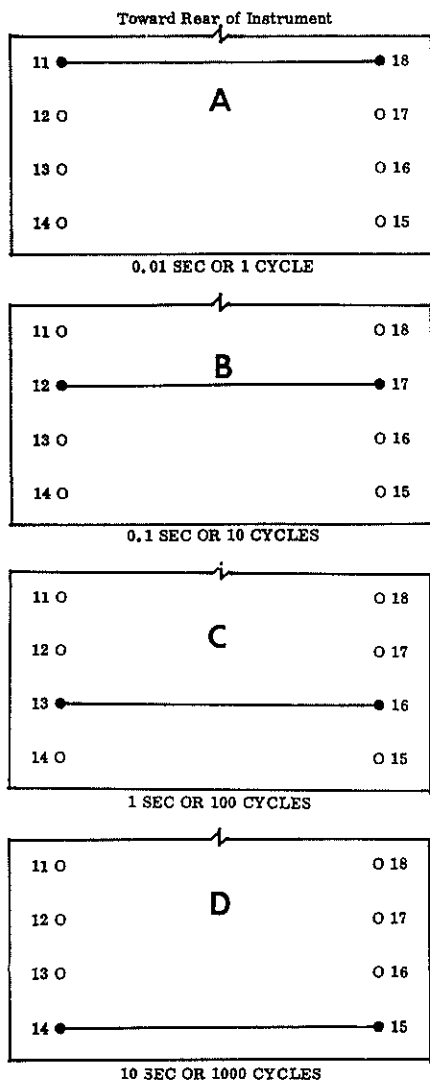

Figure 6. Time Base or Number of Cycles Selection

OPERATION.

INPUTS.

As described above, the RC-5TB can accept inputs from either contact-closures or electronic sources. Special contact de-bouncing circuits are provided to handle either single-pole double-throw or single-pole single-throw contacts. When possible, the use of single-pole double-throw contacts is recommended because the de-bouncing circuitry is simpler. In the frequency, period and unit counter functions, inputs from electronic sources may be connected to either of two inputs. Low frequency sine wave inputs (below 10 kHz) are connected to terminal 7, the normally-open contact input. The circuitry associated with this input converts the sine waves to square waves for proper operation of the counter. Sine wave inputs 10 kHz and above are connected to terminal 1. The input common for all frequencies is terminal 5.

The RC-5TB counts high-to-low transitions at input A (terminal 1) and input B (terminal 2). The switching threshold is approximately +2 volts. For proper operation the signals at inputs A and B should fall at a rate not less than 150 millivolts per microsecond when the switching threshold is crossed. Electronic signals falling at a rate less than 150 millivolts per microsecond should be connected to terminal 7.

A 0.05 μ F capacitor is furnished with the RC-5TB. This capacitor is needed only for single-pole single-throw contact-closure inputs. When used, it should be soldered between pins 1 and 28 of the program header. Details on the capacitor are as follows:

- NLS Stock No. - 201350
- Manufacturer - Centralab
- Mfr Part No. - UK20-503
- Description - 0.05 μ F (+80, -20%), 20V

The function of the capacitor is to provide sufficient delay to allow the contacts to stop bouncing before a count is registered. While the value of 0.05 μ F should be satisfactory in most applications, extremely rapid contact-closure operation may require a smaller value of capacitance. Extremely slow operation may require a larger value.

Note that for single-pole double-throw operation no capacitor is needed regardless of the speed of operation.

INPUT AMPLITUDE AND IMPEDANCE.

The internal circuit configuration for inputs A (terminal 1) and B (terminal 2) are the same and are shown in figure 7.

The recommended input signal is 5 volts peak-to-peak amplitude, going between 0 and +5V. For signals in this voltage range, the input impedance is 110 k Ω , 10 k Ω of which is shunted by a 390 pF capacitor. Signals up to 30 volts peak-to-peak can be accommodated. However, for signals above +5.6V and below -0.6V the clamp diodes conduct and the input impedance falls to 10 k Ω shunted by 390 pF. It is emphasized that for reliable counting using inputs A and/or B, care should be taken to ensure that the input signals fall through the threshold of +2 volts at a rate not less than 150 millivolts per microsecond.

HOLD.

The RC-5TB has a "Hold" capability. When the unit is placed in "Hold" in the measurement of period, frequency, frequency ratio and time interval, the main counter is reset and the last complete measurement is displayed; when measuring unit count, the main counter continues to count but the display shows the total at the time the counter was placed in "Hold". See figure 12"A" and "C" for "Hold" connection information.

RESET.

The RC-5TB includes a "Reset" capability. When the "Reset" signal is applied, the main

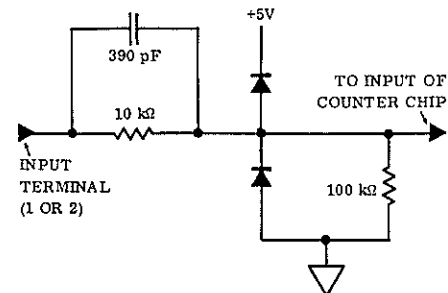

Figure 7. Internal Circuit for Inputs A and B counter and display are reset to zero in all functions. See figure 12"B" and "D" for "Reset" connection information.

CALIBRATION.

When the RC-5TB is used as a unit counter or frequency ratio meter, calibration is not required. When used to measure frequency, period or time interval, calibration may be necessary. To calibrate the instrument, perform the following steps:

1. Remove meter from case by performing steps 1 thru 4 under Wire Information.
2. Jumper between pins of program header as shown in figure 4"D".
3. Jumper between pins of program header as shown in figure 5"C".
4. Jumper between pins of program header as shown in figure 6"C".
5. Using a frequency standard as the input source, connect inputs to terminal block as shown in figure 9"C".
6. Set frequency standard to approximately 99990 Hz; the frequency setting is not critical.
7. Adjust capacitor C3 (figure 8) until display agrees with frequency standard.
8. Remove inputs and reassemble meter.

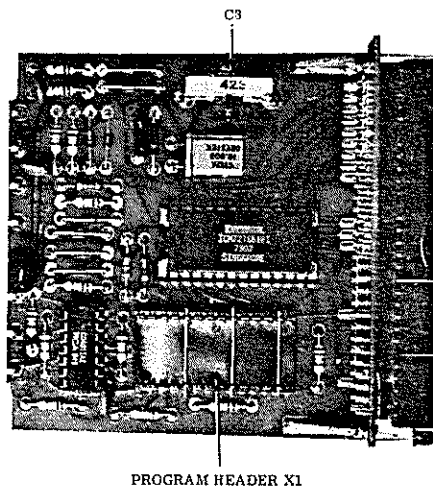

Figure 8. Calibration Adjustment

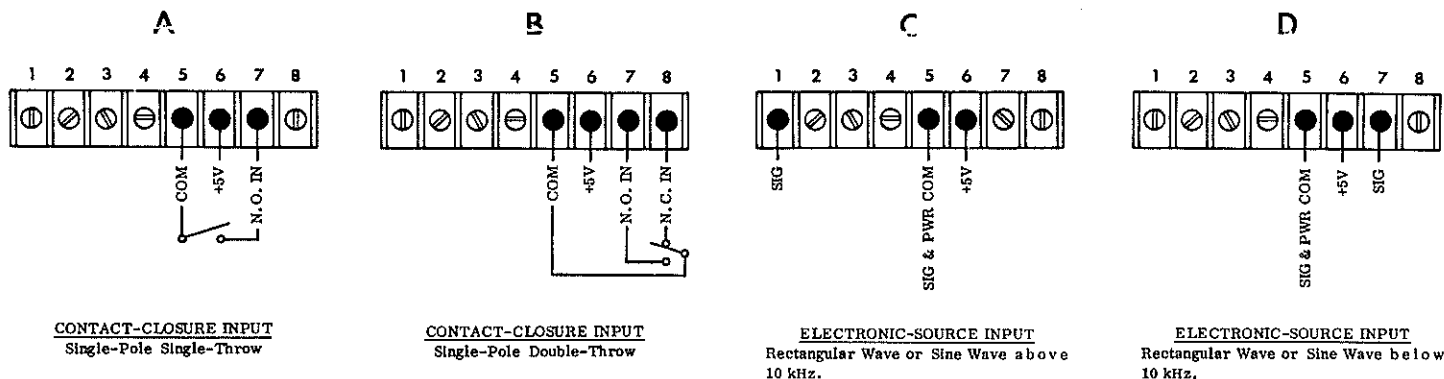

Figure 9. Input Connections for Unit Count, Frequency and Period Measurement

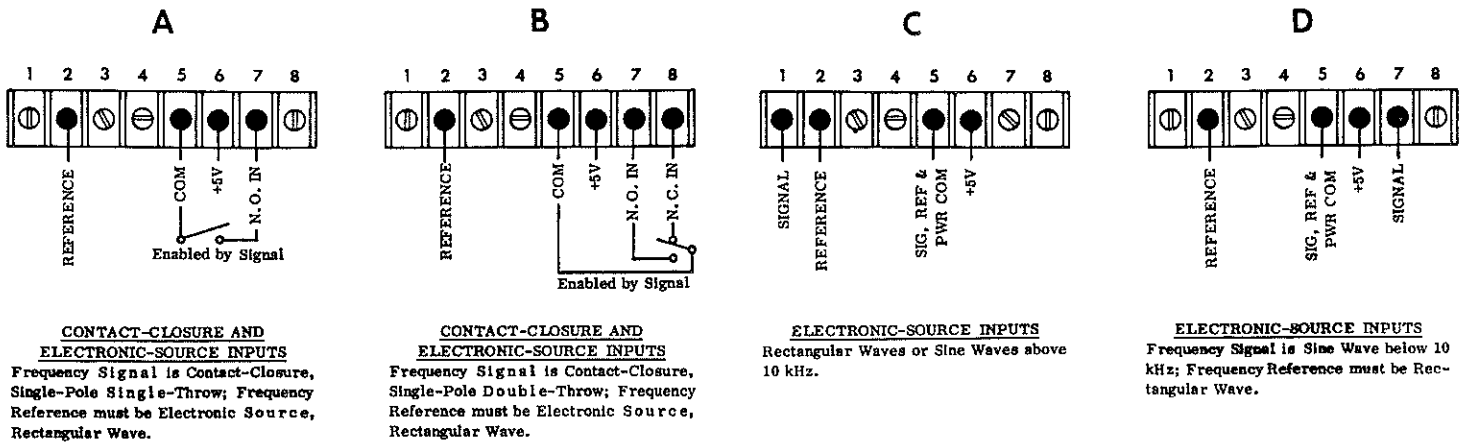

Figure 10. Input Connections for Frequency Ratio Measurement

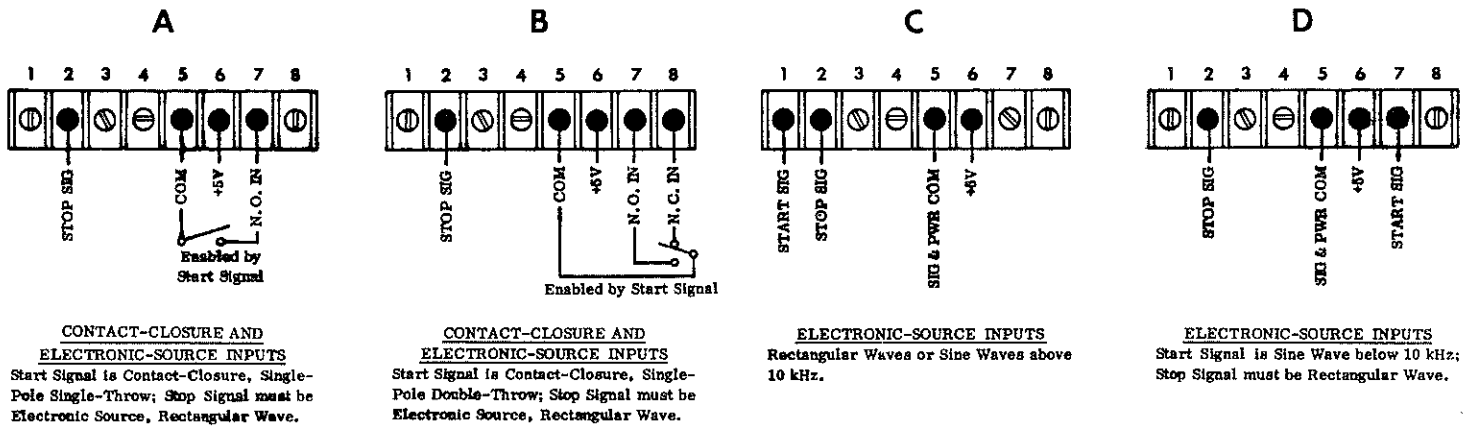

Figure 11. Input Connections for Time Interval Measurement

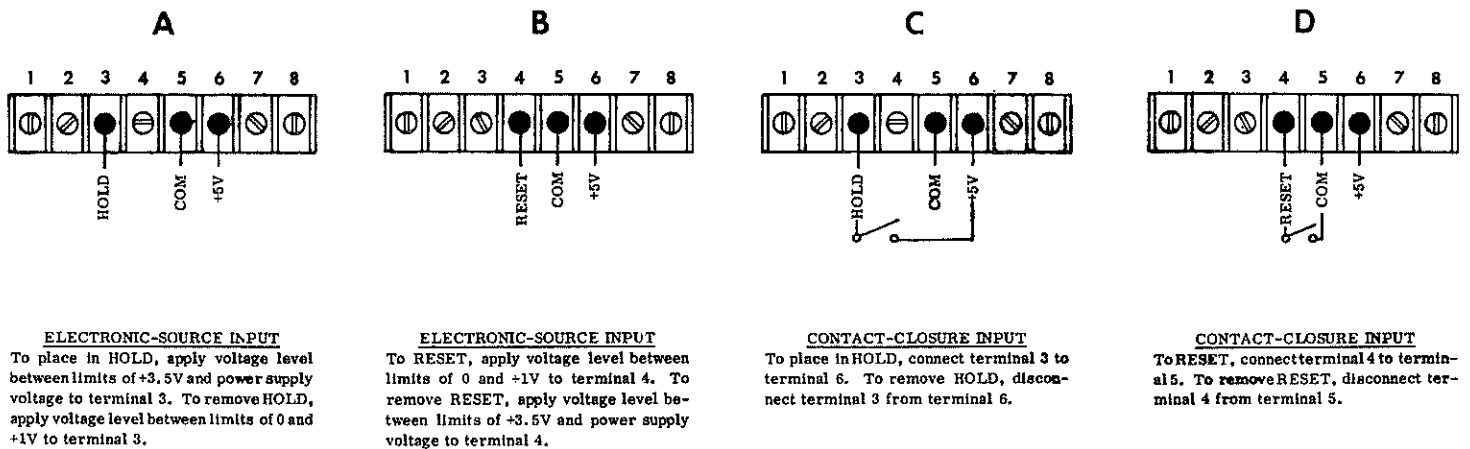

Figure 12. Hold and Reset Connections



NON-LINEAR SYSTEMS
Originator of the digital voltmeter
 4561-F Mission Gorge Place
 San Diego, CA 92120
 Phone: 619-521-2161
 Fax: 619-521-2169
 www.nonlinearsystems.com